

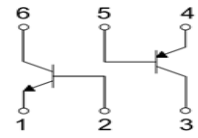

### BC846PNV Plastic-Encapsulate Transistors

DUAL TRANSISTOR (NPN+PNP)



#### FEATURES

- Epitaxial Die Construction
- Two isolated NPN/PNP(BC846+BC856) Transistors in one package

MAKING: PJ

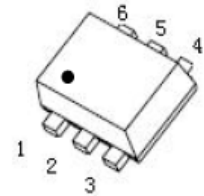

#### MAXIMUM RATINGS TR1 (T<sub>a</sub>=25°C unless otherwise noted)

Symbol	Parameter	Value	Units
V <sub>CBO</sub>	Collector-Base Voltage	80	V
V <sub>CEO</sub>	Collector-Emitter Voltage	65	V
V <sub>EBO</sub>	Emitter-Base Voltage	6	V
I <sub>C</sub>	Collector Current –Continuous	0.1	A
P <sub>C</sub>	Collector Power Dissipation	200	mW
T <sub>J</sub>	Junction Temperature	150	°C
T <sub>stg</sub>	Storage Temperature	-55-150	°C

SOT-563

#### CHARACTERISTICS of TR1 (NPN Transistor) (T<sub>a</sub>=25°C unless otherwise specified)

Parameter	Symbol	Test conditions	Min	Typ	Max	Unit
Collector-base breakdown voltage	V <sub>(BR)CBO</sub>	I <sub>C</sub> =10μA, I <sub>E</sub> =0	80			V
Collector-emitter breakdown voltage	V <sub>(BR)CEO</sub>	I <sub>C</sub> =10mA, I <sub>B</sub> =0	65			V
Emitter-base breakdown voltage	V <sub>(BR)EBO</sub>	I <sub>E</sub> =1μA, I <sub>C</sub> =0	6			V
Collector cut-off current	I <sub>CBO</sub>	V <sub>CB</sub> =30V, I <sub>E</sub> =0			15	nA
Emitter cut-off current	I <sub>EBO</sub>	V <sub>EB</sub> =5V, I <sub>C</sub> =0			15	nA
DC current gain	h <sub>FE</sub>	V <sub>CE</sub> =5V, I <sub>C</sub> =2mA	200		450	
Collector-emitter saturation voltage	V <sub>CE(sat)</sub>	I <sub>C</sub> =10mA, I <sub>B</sub> =0.5mA			0.25	V
	V <sub>CE(sat)</sub>	I <sub>C</sub> =100mA, I <sub>B</sub> =5mA			0.6	V
Base-emitter saturation voltage	V <sub>BE(sat)</sub>	I <sub>C</sub> =10mA, I <sub>B</sub> =0.5mA		0.7		V
	V <sub>BE(sat)</sub>	I <sub>C</sub> =100mA, I <sub>B</sub> =5mA		0.9		V
Base-emitter voltage	V <sub>BE(on)</sub>	V <sub>CE</sub> =5V, I <sub>C</sub> =2mA	0.58		0.7	V
	V <sub>BE(on)</sub>	V <sub>CE</sub> =5V, I <sub>C</sub> =10mA			0.72	V
Collector output capacitance	C <sub>ob</sub>	V <sub>CB</sub> =10V, I <sub>E</sub> =0, f=1MHz			6.0	pF
Transition frequency	f <sub>T</sub>	V <sub>CE</sub> =5V, I <sub>C</sub> =10mA, f=100MHz	100			MHz
Noise figure	NF	V <sub>CE</sub> =5V, I <sub>C</sub> =0.2mA, f=1kHz, R <sub>g</sub> =2KΩ, Δf=200Hz			10	dB



### MAXIMUM RATINGS TR2 ( $T_a=25^{\circ}\text{C}$ unless otherwise noted)

Symbol	Parameter	Value	Units
$V_{\text{CBO}}$	Collector-Base Voltage	-80	V
$V_{\text{CEO}}$	Collector-Emitter Voltage	-65	V
$V_{\text{EBO}}$	Emitter-Base Voltage	-5	V
$I_{\text{C}}$	Collector Current –Continuous	-0.1	A
$P_{\text{C}}$	Collector Power Dissipation	200	mW
$T_{\text{J}}$	Junction Temperature	150	$^{\circ}\text{C}$
$T_{\text{stg}}$	Storage Temperature	-55-150	$^{\circ}\text{C}$

### CHARACTERISTICS of TR2 (PNP Transistor) ( $T_a=25^{\circ}\text{C}$ unless otherwise specified)

Parameter	Symbol	Test conditions	MIN	TYP	MAX	UNIT
Collector-base breakdown voltage	$V_{(\text{BR})\text{CBO}}$	$I_{\text{C}}=-10\mu\text{A}, I_{\text{E}}=0$	-80			V
Collector-emitter breakdown voltage	$V_{(\text{BR})\text{CEO}}$	$I_{\text{C}}=-10\text{mA}, I_{\text{B}}=0$	-65			V
Emitter-base breakdown voltage	$V_{(\text{BR})\text{EBO}}$	$I_{\text{E}}=-1\mu\text{A}, I_{\text{C}}=0$	-5			V
Collector cut-off current	$I_{\text{CBO}}$	$V_{\text{CB}}=-30\text{V}, I_{\text{E}}=0$			-15	nA
Emitter cut-off current	$I_{\text{EBO}}$	$V_{\text{EB}}=-5\text{V}, I_{\text{C}}=0$			-15	nA
DC current gain	$h_{\text{FE}1}$	$V_{\text{CE}}=-5\text{V}, I_{\text{C}}=-2\text{mA}$	220		475	
Collector-emitter saturation voltage	$V_{\text{CE}(\text{sat})}$	$I_{\text{C}}=-10\text{mA}, I_{\text{B}}=-0.5\text{mA}$			-0.3	V
	$V_{\text{CE}(\text{sat})}$	$I_{\text{C}}=-100\text{mA}, I_{\text{B}}=-5\text{mA}$			-0.65	V
Base-emitter saturation voltage	$V_{\text{BE}(\text{sat})}$	$I_{\text{C}}=-10\text{mA}, I_{\text{B}}=-0.5\text{mA}$		-0.7		V
	$V_{\text{BE}(\text{sat})}$	$I_{\text{C}}=-100\text{mA}, I_{\text{B}}=-5\text{mA}$			-0.95	V
Base-emitter voltage	$V_{\text{BE}(\text{on})}$	$V_{\text{CE}}=-5\text{V}, I_{\text{C}}=-2\text{mA}$	-0.6		-0.75	V
	$V_{\text{BE}(\text{on})}$	$V_{\text{CE}}=-5\text{V}, I_{\text{C}}=-10\text{mA}$			-0.82	V
Collector output capacitance	$C_{\text{ob}}$	$V_{\text{CB}}=-10\text{V}, I_{\text{E}}=0, f=1\text{MHz}$			4.5	pF
Transition frequency	$f_{\text{T}}$	$V_{\text{CE}}=-5\text{V}, I_{\text{C}}=-10\text{mA}, f=100\text{MHz}$	100			MHz
Noise figure	NF	$V_{\text{CE}}=-5\text{V}, I_{\text{C}}=-0.2\text{mA},$ $f=1\text{kHz}, R_{\text{g}}=2\text{K}\Omega, \Delta f=200\text{Hz}$			10	dB



## Typical Characteristics

BC846PNV/TR1

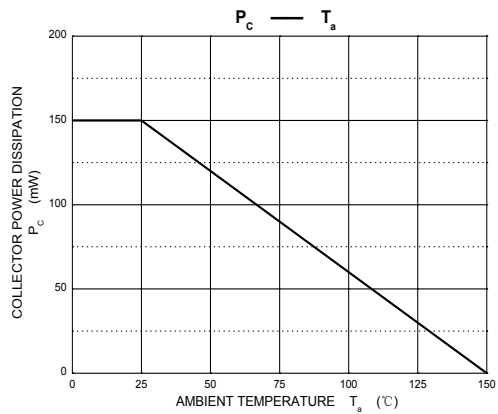
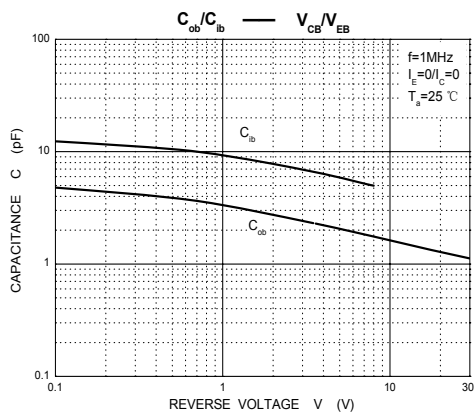
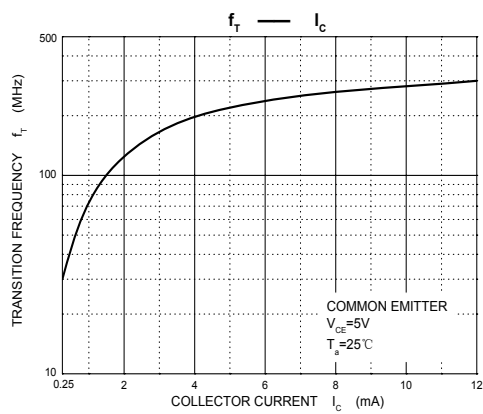
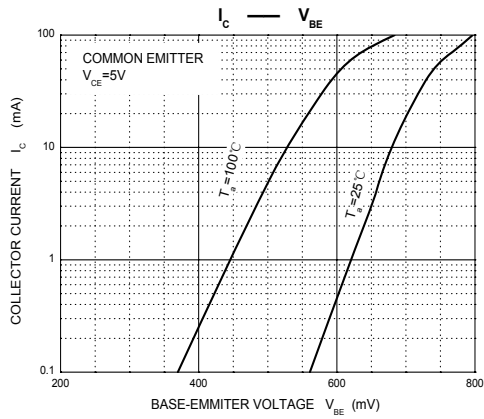
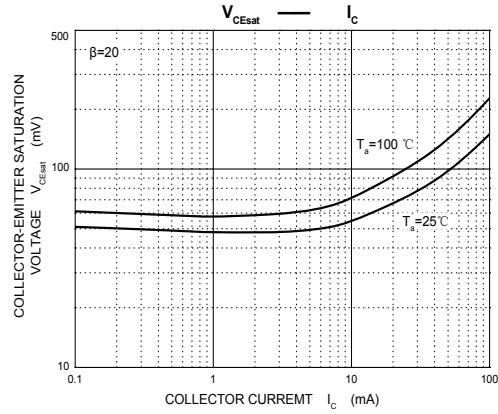
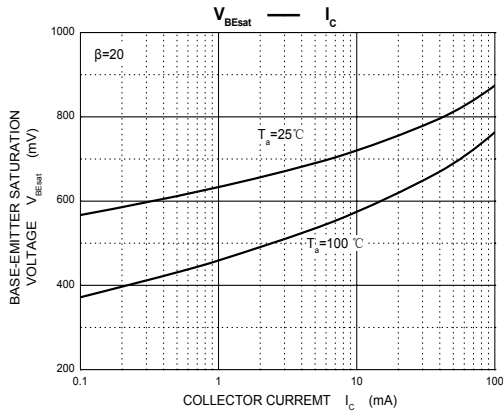
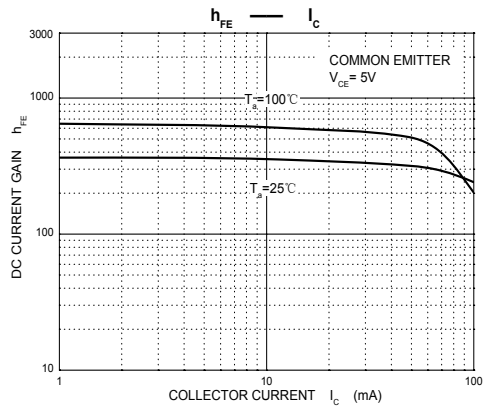
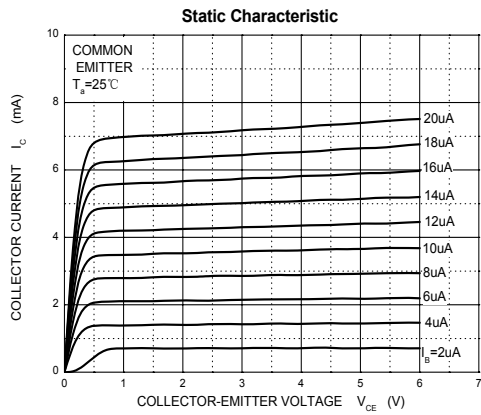



## Typical Characteristics

BC846PNV/TR2

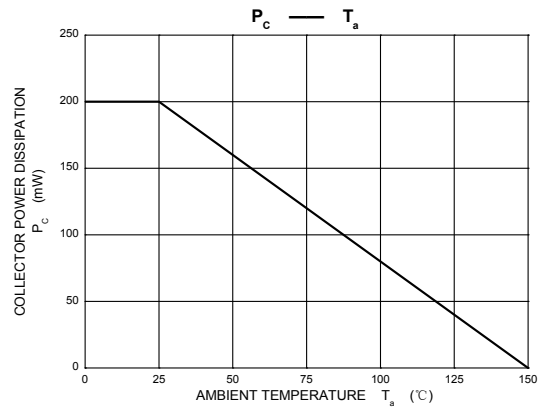
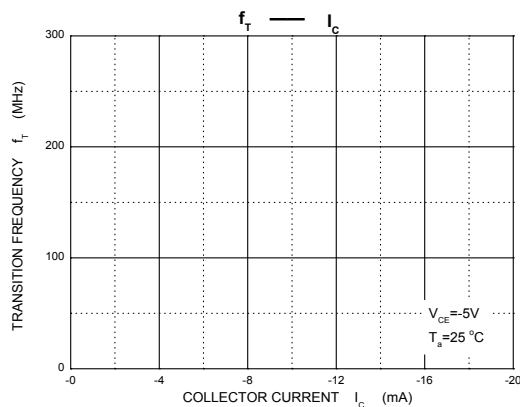
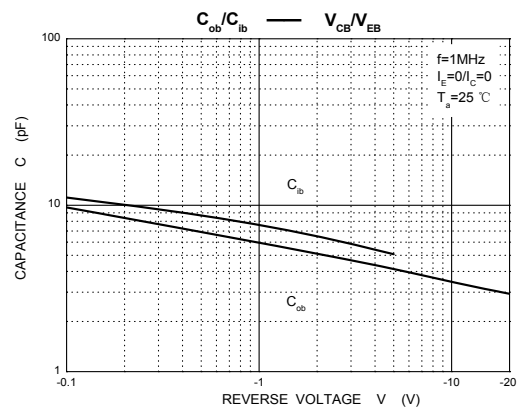
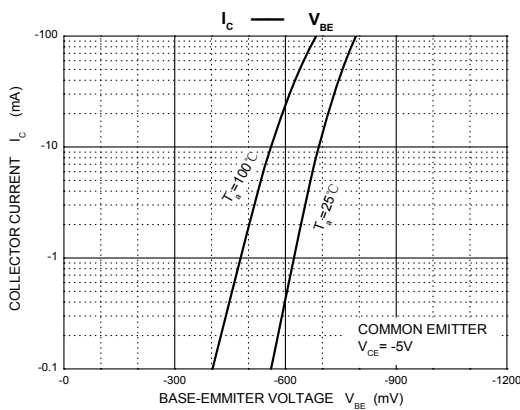
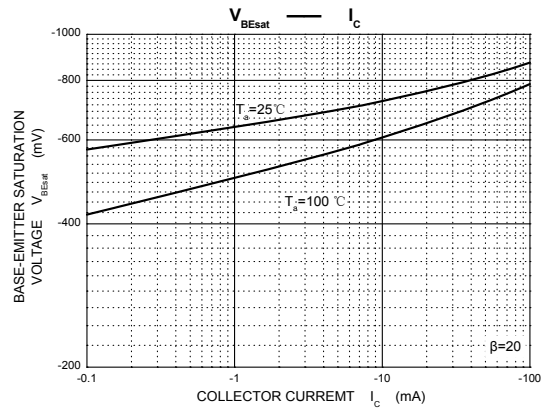
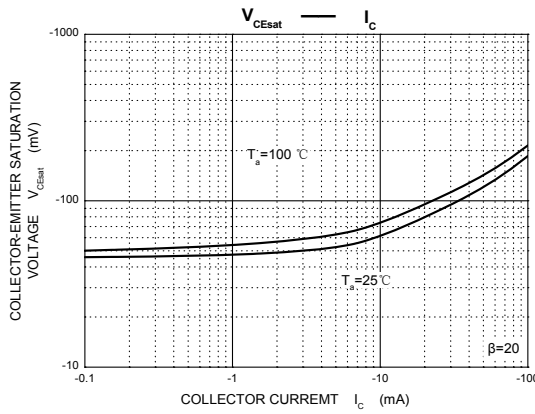
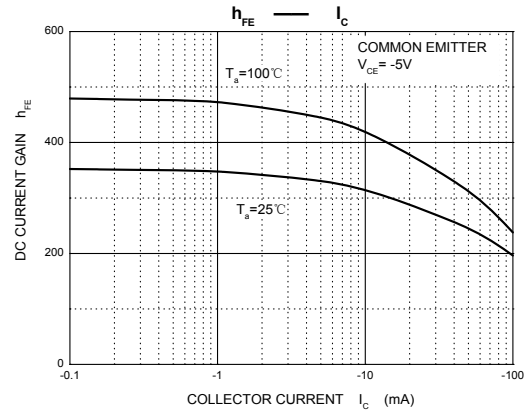
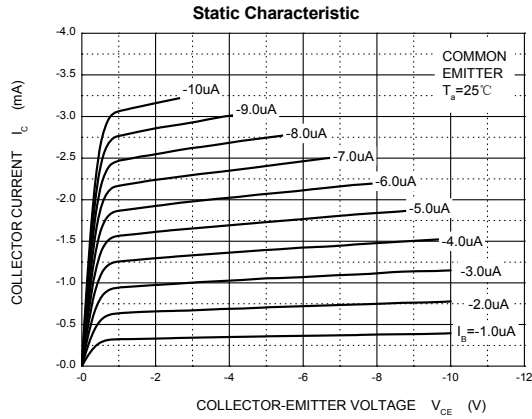



### SOT-563 Package Outline Dimensions

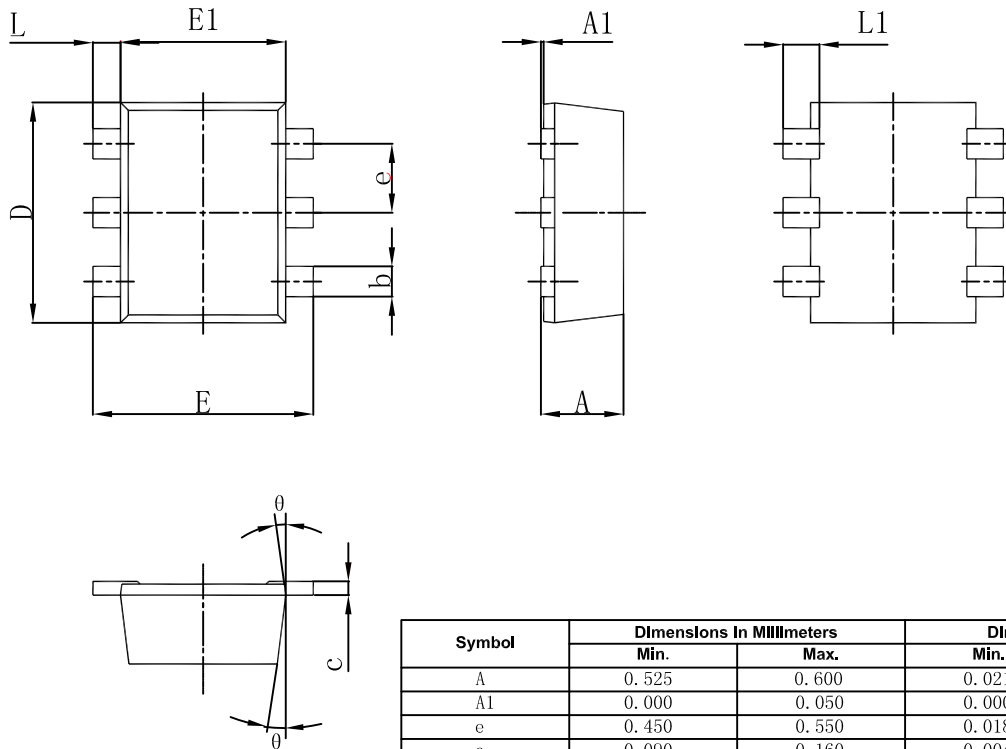

Symbol	Dimensions In Millimeters		Dimensions In Inches	
	Min.	Max.	Min.	Max.
A	0.525	0.600	0.021	0.024
A1	0.000	0.050	0.000	0.002
e	0.450	0.550	0.018	0.022
c	0.090	0.160	0.004	0.006
D	1.500	1.700	0.059	0.067
b	0.170	0.270	0.007	0.011
E1	1.100	1.300	0.043	0.051
E	1.500	1.700	0.059	0.067
L	0.100	0.300	0.004	0.012
L1	0.200	0.400	0.008	0.016
$\theta$	7 °REF.		7 °REF.	

### SOT-563 Suggested Pad Layout

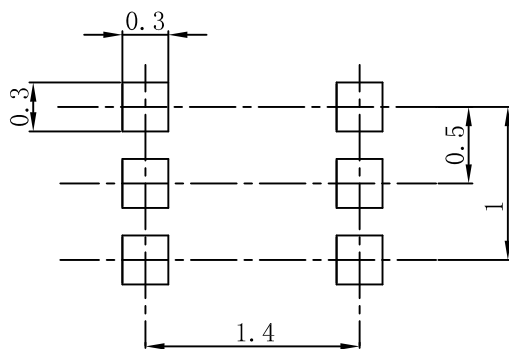

**Note:**

1. Controlling dimension: in millimeters.
2. General tolerance:  $\pm 0.05\text{mm}$ .
3. The pad layout is for reference purposes only.



### SOT-563 Embossed Carrier Tape

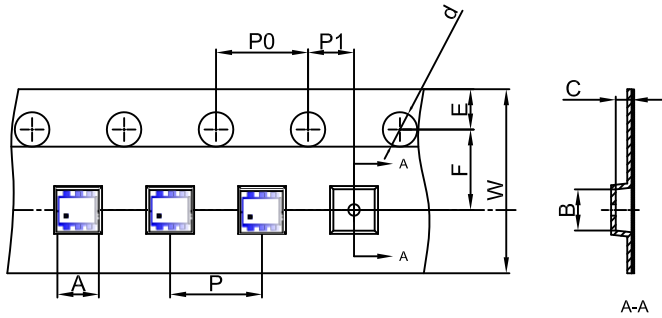

**Packaging Description:**  
 SOT-563 parts are shipped in tape. The carrier tape is made from a dissipative (carbon filled) polycarbonate resin. The cover tape is a multilayer film (Heat Activated Adhesive in nature) primarily composed of polyester film, adhesive layer, sealant, and anti-static sprayed agent. These reeled parts in standard option are shipped with 3,000 units per 7" or 17.8cm diameter reel. The reels are clear in color and is made of polystyrene plastic (anti-static coated).

Dimensions are in millimeter

Pkg type	A	B	C	d	E	F	P0	P	P1	W
SOT-563	1.78	1.78	0.69	Ø1.50	1.75	3.50	4.00	4.00	2.00	8.00

### SOT-563 Tape Leader and Trailer

